

ZASTOSOWANIE

Wentylator przeznaczony do systemów transportu nieagresywnych i niewybuchowych gazów bez zanieczyszczeń. Typowe zastosowania to:

- nawiew / wywiew w indywidualnych układach wentylacji i klimatyzacji,
- układy chłodzące, suszące,
- wentylacja warsztatów.

KONSTRUKCJA

- niskociśnieniowy wentylator promieniowy o napędzie bezpośrednim,
- wirnik zgrzewany z blachy stalowej z łopatkami pochylonymi do przodu, wyważony dynamicznie wg ISO 1940-1,
- obudowa odlewana ze stopu aluminium,
- siatka ochronna ocynkowana na wlocie,
- stopa pod wentylator w modelach 160A, 180-225,
- podstawa pod silnik w modelu 250,
- wentylator malowany na kolor szary RAL 7042,
- maksymalna temperatura tłoczonego medium 80°C,
- temperatura otoczenia silnika od -20°C do +40°C,
- figura LG270.

SILNIK ELEKTRYCZNY

- asynchroniczny, jednofazowy, 230V, 50Hz (o mocy do 1,5 kW),
- asynchroniczny, trójfazowy, 230/400V, 50Hz (o mocy do 3 kW),
- asynchroniczny, trójfazowy, 400/690V, 50Hz (o mocy od 4 kW),
- stopień ochrony IP55,
- klasa izolacji F,
- do regulacji częstotliwościowej (silniki trójfazowe).

WYKONANIA SPECJALNE

- dowolna figura LG/RD,
- malowanie na kolor inny niż standardowy,
- silnik na inne niż standardowe napięcie oraz częstotliwość zasilania,
- silnik o innym stopniu ochrony IP,
- silnik wyposażony w czujniki lub dodatkowe chłodzenie,
- uszczelnienie między obudową a silnikiem (simmering),
- temperatura otoczenia silnika poniżej -20°C oraz powyżej +40°C.



FIGURY

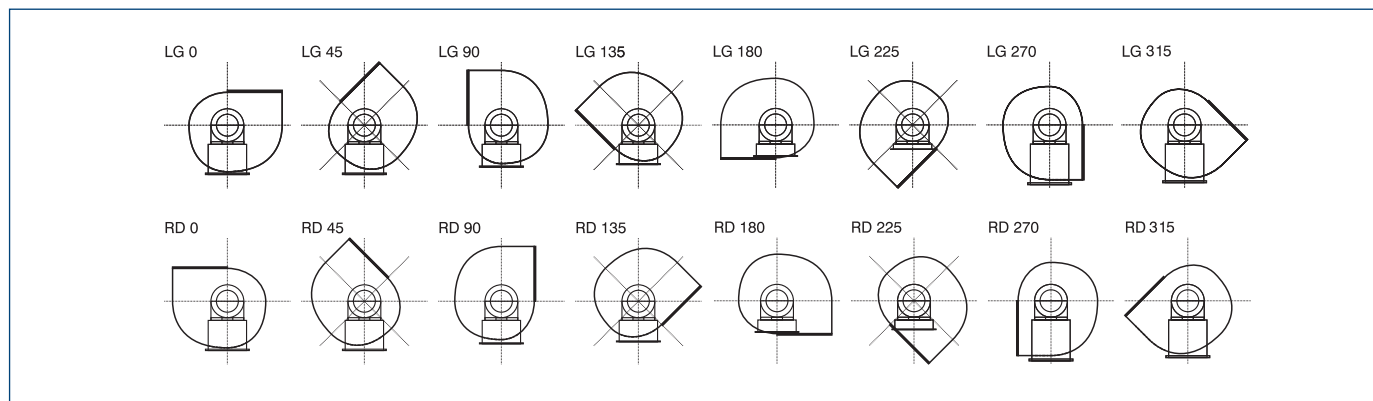

DANE TECHNICZNE

Typ	wydajność max	ciśnienie max	moc silnika	prędkość obrotowa	natężenie	napięcie	kondensator	poziom ciśnienia akust.*	masa	ErP	nr artykułu
	[m³/h]	[Pa]	[kW]	[obr/min]	[A]	[V]	[µF]	[dB(A)]	[kg]		
LFA/2-108/42-005T	205	330	0,05	2900	0,55/0,32	230/400	-	64	3,85	Nie podlega	45010010
LFA/2-108/42-003S	195	300	0,03	2850	0,9	230	4	64	4	Nie podlega	45010020
LFA/4-108/42-006T	105	82	0,06	1400	0,43/0,25	230/400	-	61	3,6	Nie podlega	45010015
LFA/4-108/42-006S	100	75	0,06	1400	0,29	230	4	61	3,6	Nie podlega	45010023
LFA/2-120/52-012T	510	380	0,12	2800	0,7/0,4	230/400	-	66	5,5	Nie podlega	45010025
LFA/4-120/52-006T	255	95	0,06	1400	0,43/0,25	230/400	-	46	5,2	Nie podlega	45010027
LFA/4-120/52-006S	255	95	0,06	1400	0,29	230	4	46	5,2	Nie podlega	45010028
LFA/2-133/62-018T	690	580	0,18	2760	0,85/0,50	230/400	-	69	6,2	2015	435010030
LFA/2-133/62-018S	680	610	0,18	2840	1,4	230	8	69	6,2	2015	435010040
LFA/4-133/62-006T	340	150	0,06	1400	0,43/0,25	230/400	-	47	5,2	Nie podlega	45010037
LFA/4-133/62-006S	295	150	0,06	1400	0,29	230	4	47	5,5	Nie podlega	45010038
LFA/2-146/62-025T	760	670	0,25	2790	1,10/0,65	230/400	-	70	6,5	2015	435010105
LFA/2-146/62-025S	660	680	0,25	2890	1,6	230	8	70	6,5	2015	435010110
LFA/4-146/62-006T	375	175	0,06	1400	0,43/0,25	230/400	-	54	6,4	Nie podlega	45010106
LFA/4-146/62-006S	320	180	0,06	1400	0,29	230	4	54	6,4	Nie podlega	45010109
LFA/2-160/75-037T	920	880	0,37/0,43	2870	1,65/0,95	230/400	-	71	9,2	2015	435010070
LFA/2-160/75-037S	855	848	0,37	2880	2,2	230	25	71	9,4	2015	435010080
LFA/4-160/75-009T	550	195	0,09	1400	0,7/0,4	230/400	-	65	7,1	Nie podlega	45010076
LFA/4-160/75-009S	550	220	0,09	1420	0,95	230	4	65	7,1	Nie podlega	45010077
LFA/2-160A/62-055T	1125	920	0,55	2870	2,15 / 1,25	230/400	-	72	12,9	2015	435010141
LFA/2-160A/62-055S	1180	955	0,55	2870	3,1	230	35	72	12,6	2015	435010143
LFA/4-160A/62-018T	715	220	0,18	1400	0,95 / 0,55	230/400	-	57	10,8	2015	435010149
LFA/4-160A/62-018S	680	220	0,18	1400	1,1	230	16	57	11,1	2015	435010150
LFA/2-180/62-055T	1080	975	0,55	2870	2,15/1,25	230/400	-	77	10,85	2015	435010090
LFA/2-180/62-055S	1090	1010	0,55	2870	3,1	230	35/450	77	11	2015	435010100
LFA/4-180/62-012T	530	235	0,12	1340	1,2/0,7	230/400	-	62	10,75	Nie podlega	435010095
LFA/4-180/62-018S	530	235	0,18	1400	1,1	230	16	62	9,1	Nie podlega	435010096
LFA/2-180/85-110T	1970	1120	1,1	2890	4,3/2,5	230/400	-	79	19,2	2015	435010102
LFA/2-180/85-110S	1840	1250	1,1	2900	5,8	230	70/450	79	19,5	2015	435010103
LFA/4-180/85-018T	1070	270	0,18	1340	1,2/0,7	230/400	-	71	14,7	2015	435010106
LFA/4-180/85-018S	1070	270	0,18	1400	1,1	230	16	71	14,7	2015	435010107
LFA/2-200/74-150T	2090	1355	1,5	2880	5,25/3,0	230/400	-	78	25,2	2015	435010130
LFA/2-200/74-150S	2160	1345	1,5	2920	8	230	90/450	76	26,5	2015	435010133
LFA/2-215/102-220T	2975	1500	2,2	2885	7,9/4,6	230/400	-	79	29	2015	435010115
LFA/2-225/104-300T	3535	1875	3	2870	11,0/6,3	230/400	-	80	35,4	2015	435010060
LFA/2-250/114-550T	5125	2400	5,5	2890	9,8/5,7	400/690	-	87	37	2015	435010120

* pomiar wykonany w odległości 1,5 m od wentylatora, dla Q=2/3*Qmax

CHARAKTERYSTYKI PRACY

- p_t - ciśnienie całkowite
- p_s - ciśnienie statyczne
- p_d - ciśnienie dynamiczne

MC	Kategoria pomiarowa
EC	Kategoria sprawności
VSD	Regulacja prędkości
SR	Ilość biegów
η [%]	Sprawność
N	Współczynnik sprawności
[kW]	Pobór mocy
[m ³ /h]	Wydajność
[Pa]	Ciśnienie statyczne/całkowite
[RPM]	Prędkość obrotowa

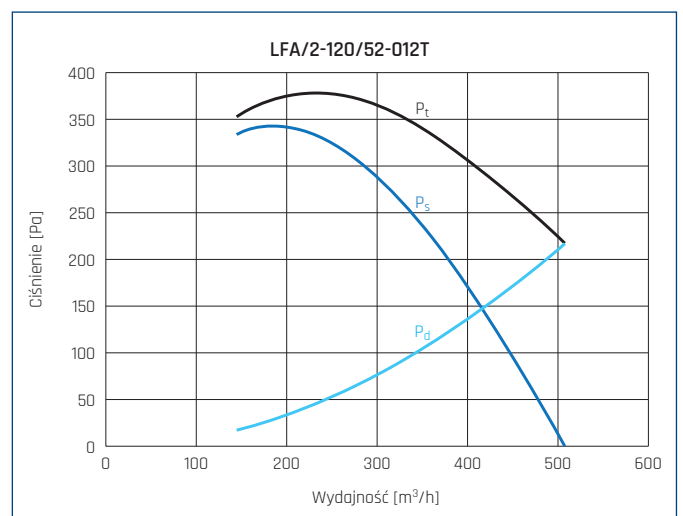
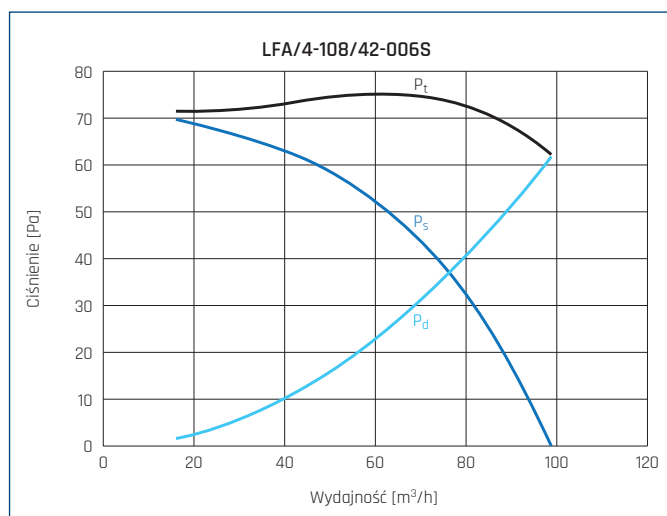
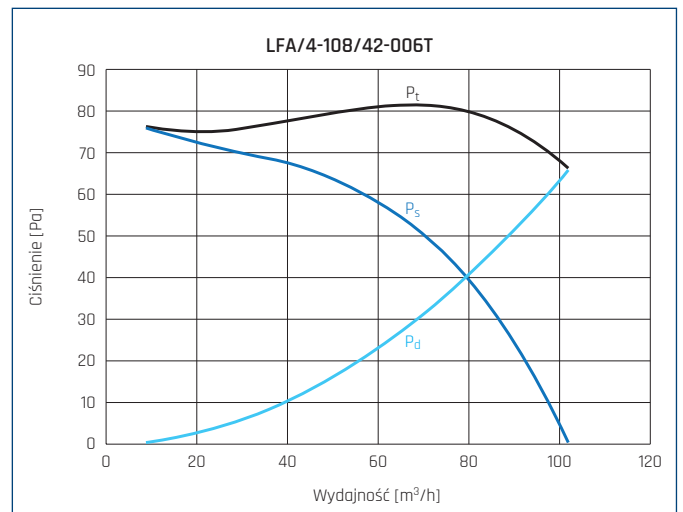
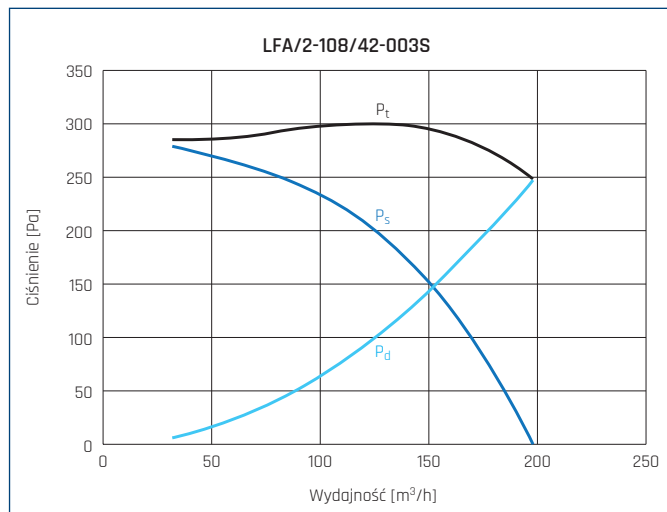
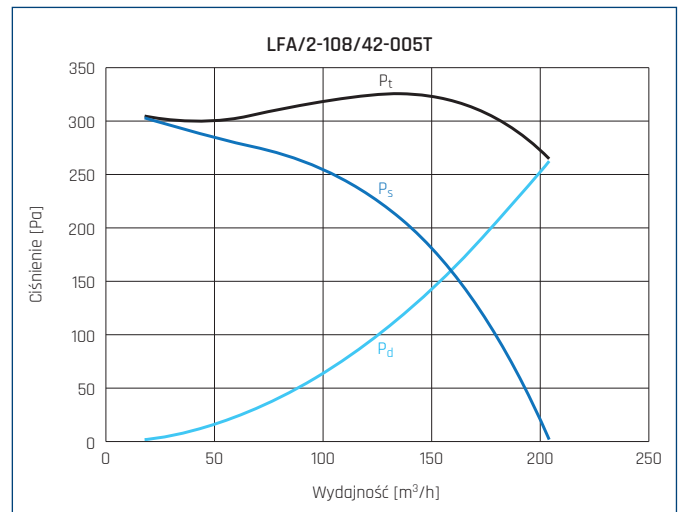

CHARAKTERYSTYKI PRACY

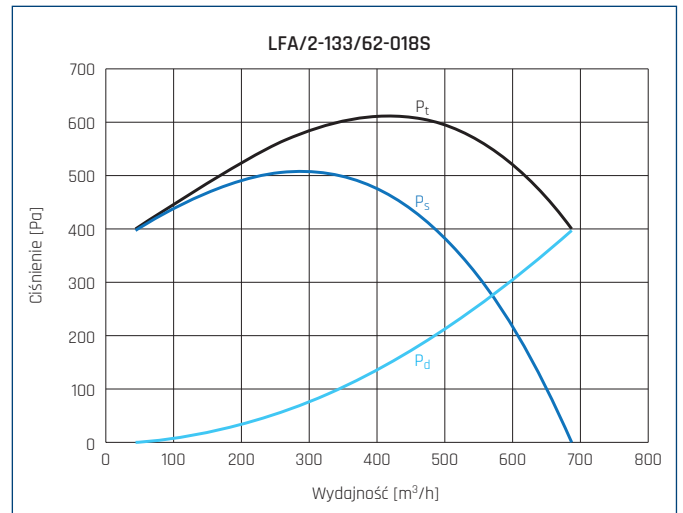
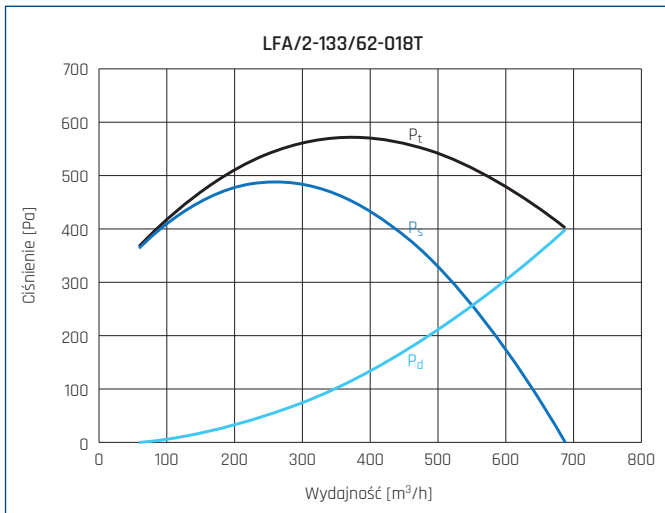
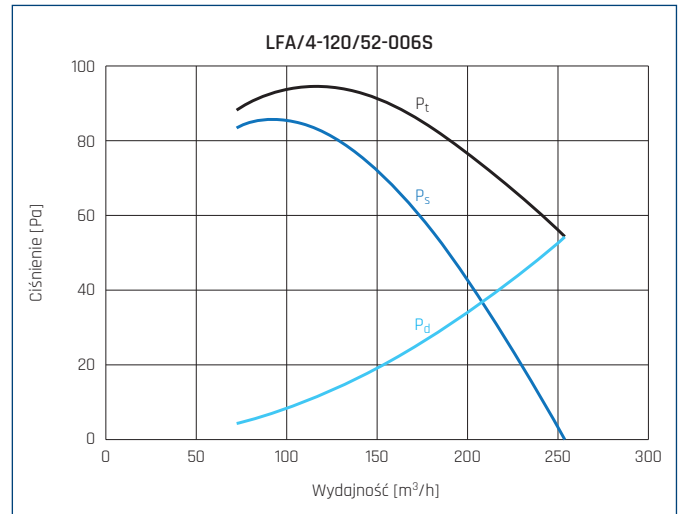
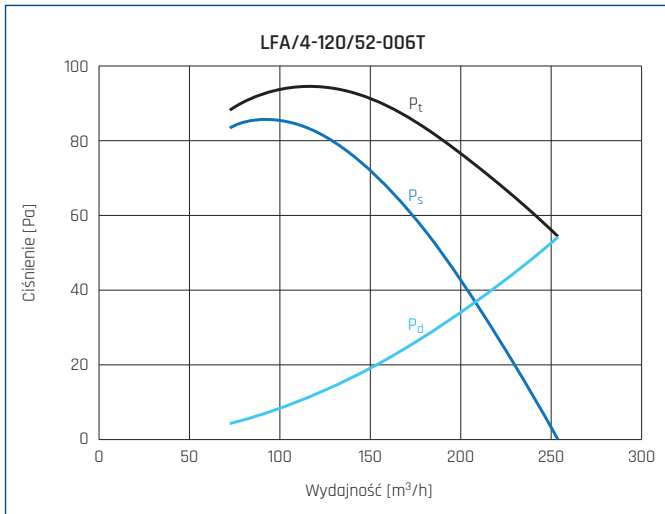

MC	EC	VSD	SR	η[%]	N	[kW]	[m³/h]	[Pa]	[RPM]
B	Całkowita	Nie	1	41,4	52,8	0,16	406	578	2889

MC	EC	VSD	SR	η[%]	N	[kW]	[m³/h]	[Pa]	[RPM]
B	Całkowita	Nie	1	39,2	49,8	0,21	484	606	2915

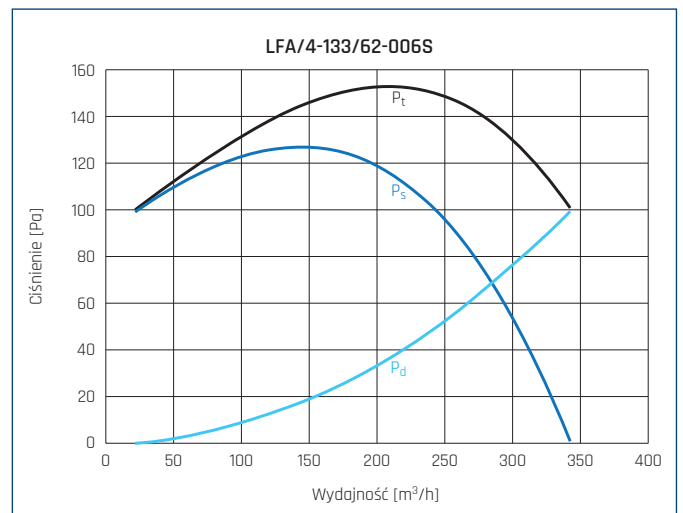
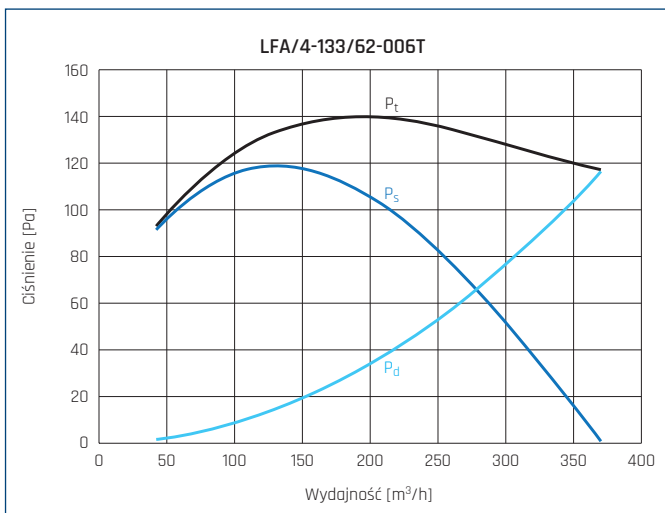

CHARAKTERYSTYKI PRACY

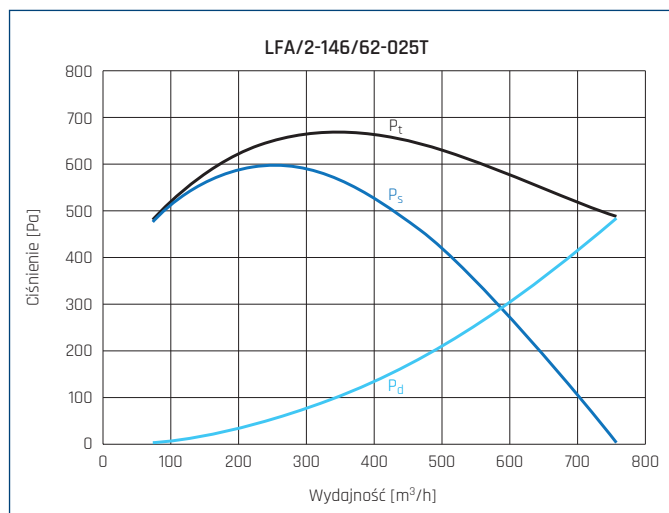

MC	EC	VSD	SR	η [%]	N	[kW]	[m³/h]	[Pa]	[RPM]
B	Całkowita	Nie	1	41,9	52,9	0,185	410	687	2918

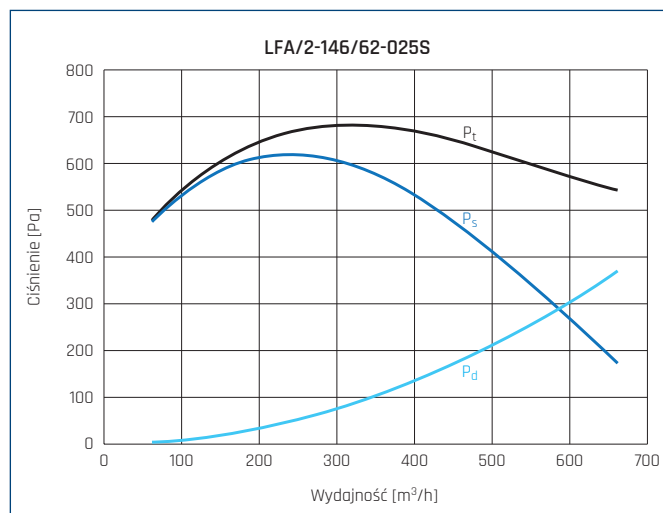

MC	EC	VSD	SR	η [%]	N	[kW]	[m³/h]	[Pa]	[RPM]
B	Całkowita	Nie	1	39,7	50,2	0,2	446	713	2890

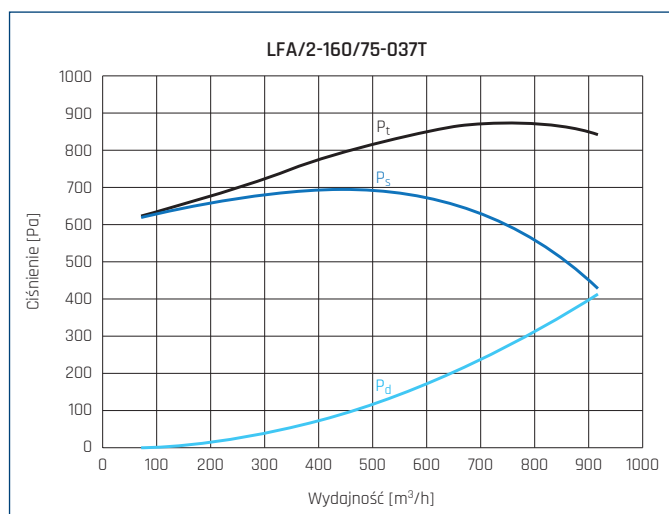
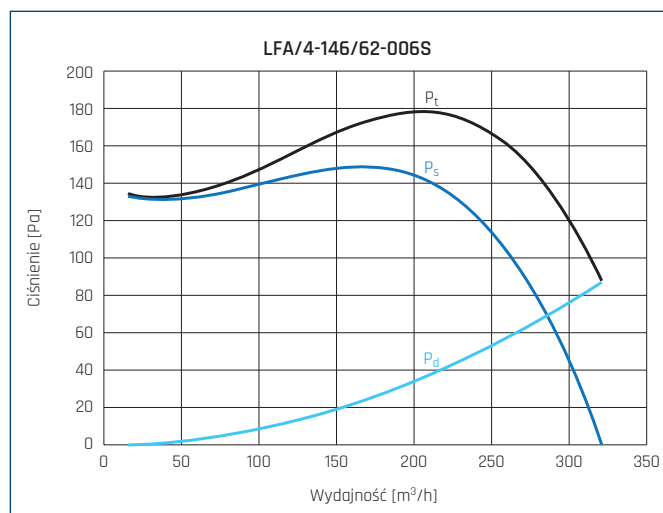
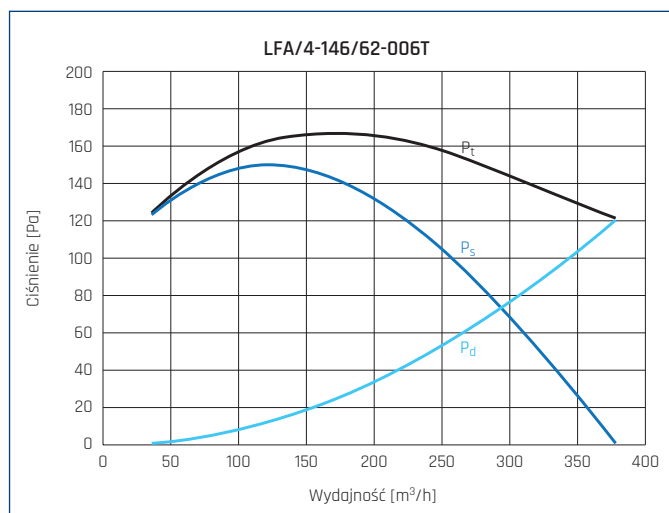

MC	EC	VSD	SR	η [%]	N	[kW]	[m³/h]	[Pa]	[RPM]
B	Całkowita	Nie	1	44,1	53,1	0,4	680	870	2900

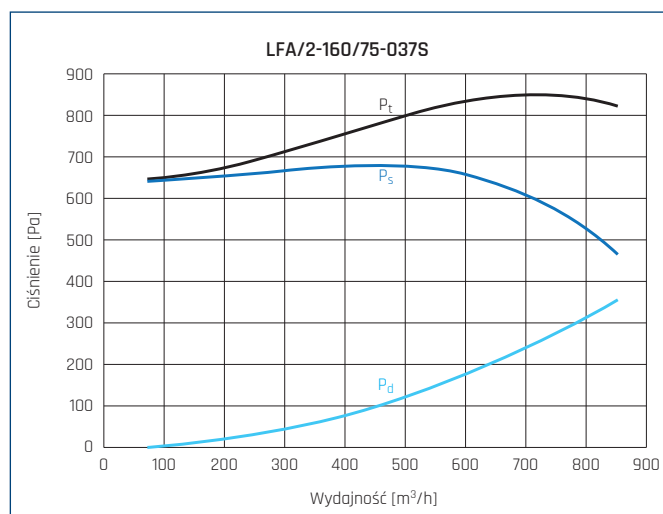

MC	EC	VSD	SR	η [%]	N	[kW]	[m³/h]	[Pa]	[RPM]
B	Całkowita	Nie	1	41,1	50,0	0,4	692	848	2880

CHARAKTERYSTYKI PRACY

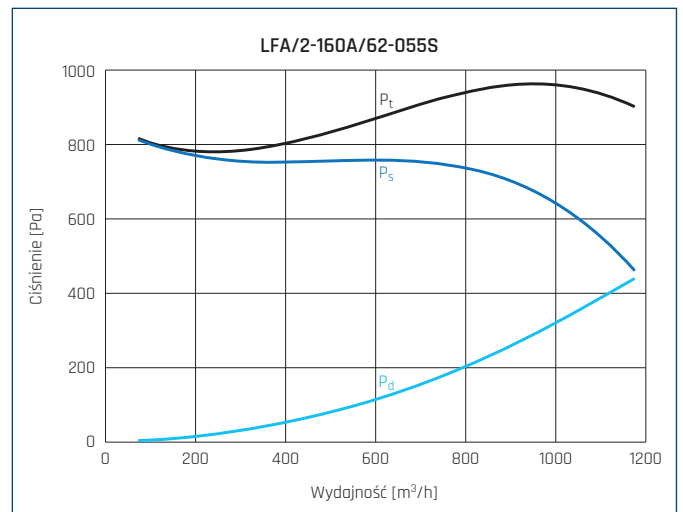
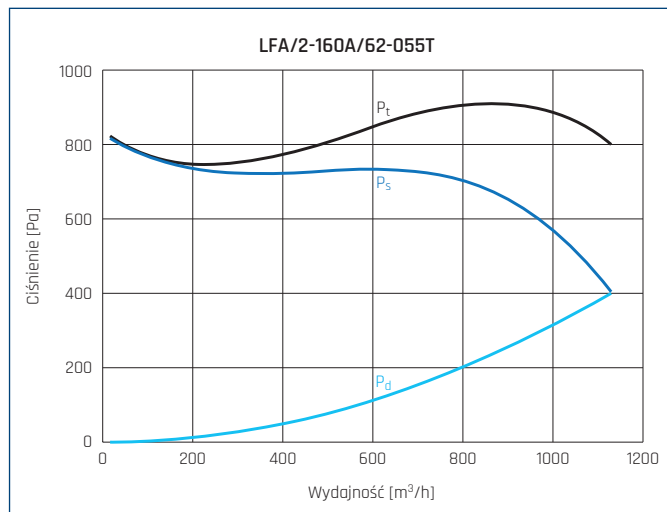
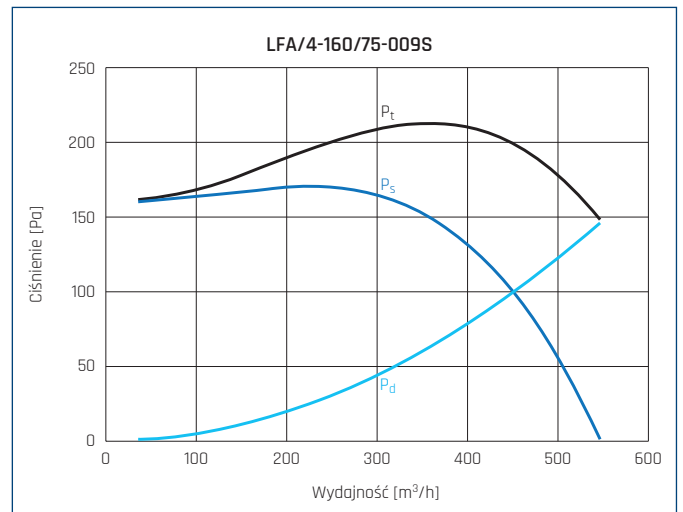
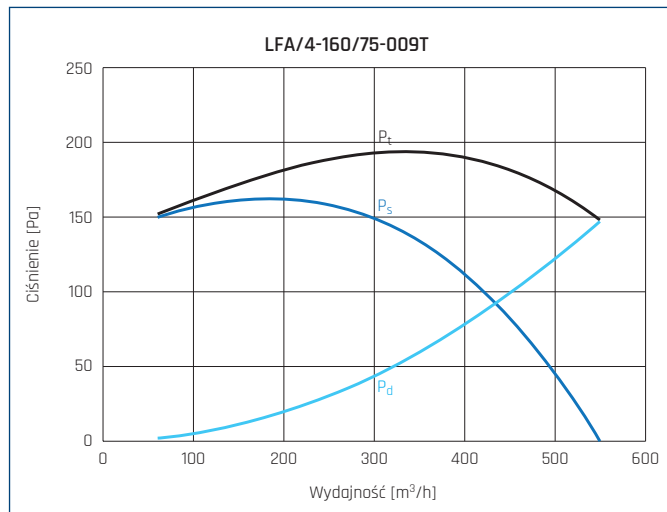

MC	EC	VSD	SR	η [%]	N	[kW]	[m³/h]	[Pa]	[RPM]
B	Całkowita	Nie	1	50,1	59,2	0,4	761	883	2939

MC	EC	VSD	SR	η [%]	N	[kW]	[m³/h]	[Pa]	[RPM]
B	Całkowita	Nie	1	44,4	52,3	0,6	946	953	2918

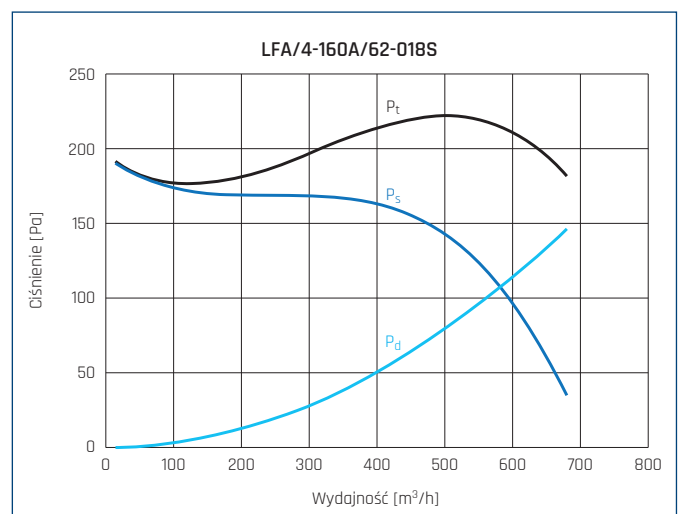
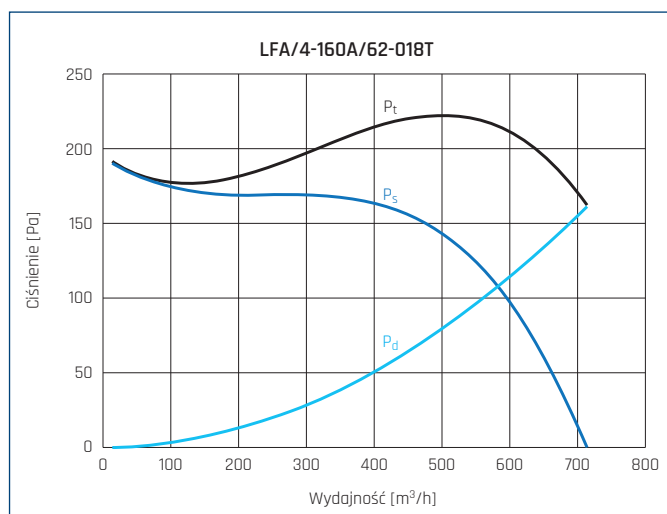

CHARAKTERYSTYKI PRACY

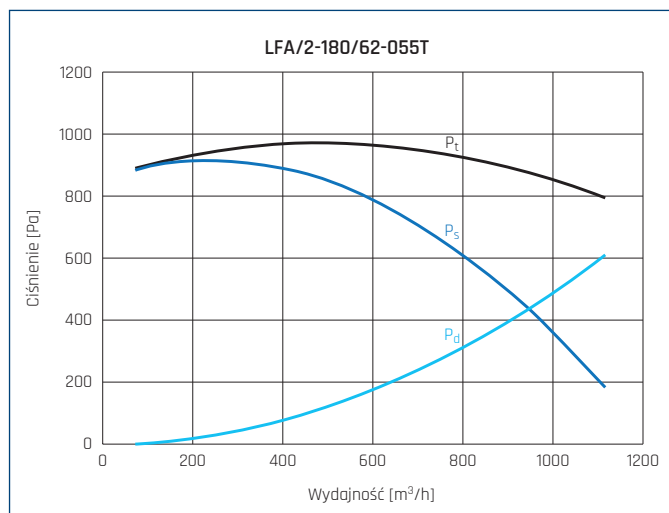

MC	EC	VSD	SR	η [%]	N	[kW]	[m³/h]	[Pa]	[RPM]
B	Całkowita	Nie	1	45,5	54,6	0,4	575	1019	2949

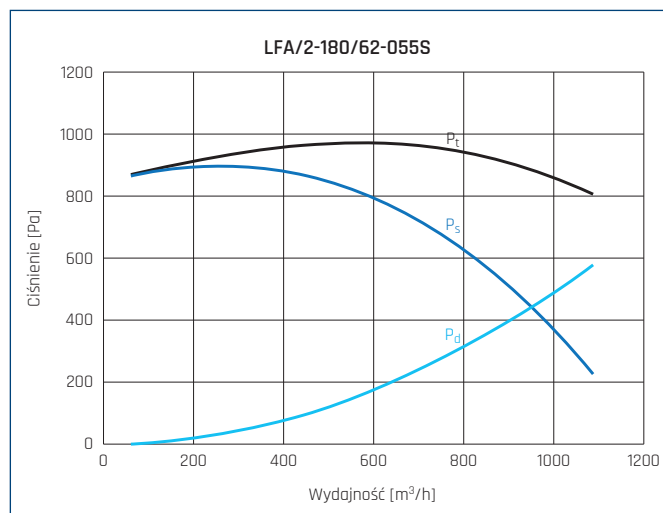

MC	EC	VSD	SR	η [%]	N	[kW]	[m³/h]	[Pa]	[RPM]
B	Całkowita	Nie	1	40,6	49,4	0,4	581	1007	2950

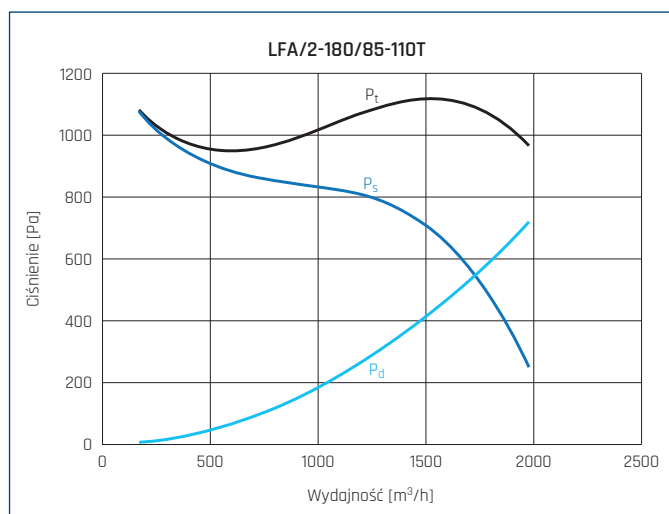
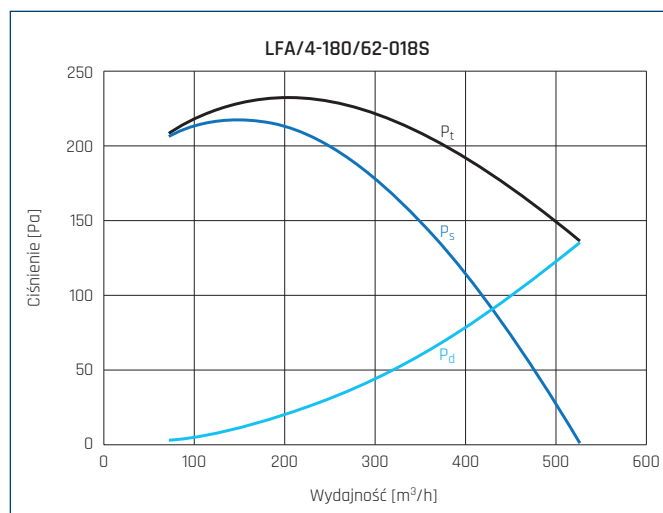
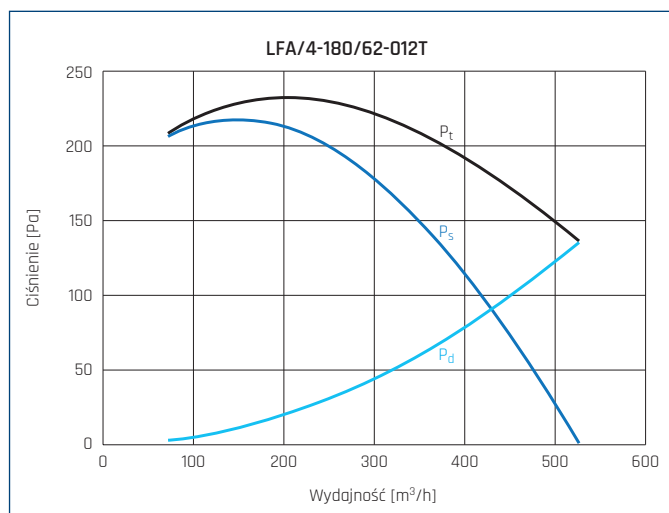

MC	EC	VSD	SR	η [%]	N	[kW]	[m³/h]	[Pa]	[RPM]
B	Całkowita	Nie	1	48,7	55,3	0,9	1441	1117	2946

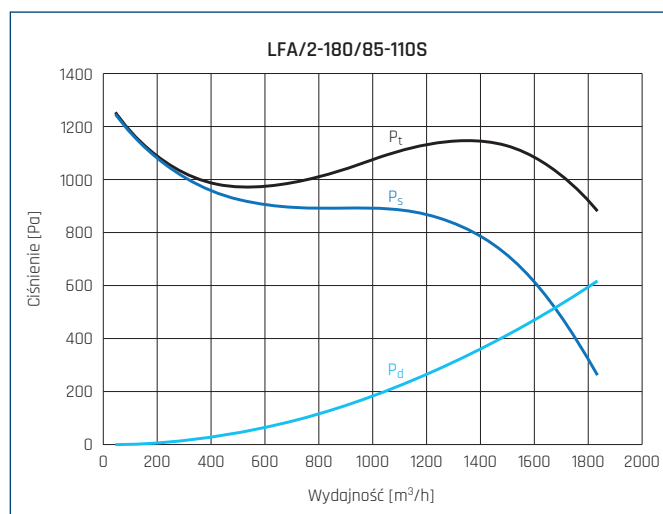

MC	EC	VSD	SR	η [%]	N	[kW]	[m³/h]	[Pa]	[RPM]
B	Całkowita	Nie	1	45,2	51,7	0,9	1330	1145	2984

CHARAKTERYSTYKI PRACY

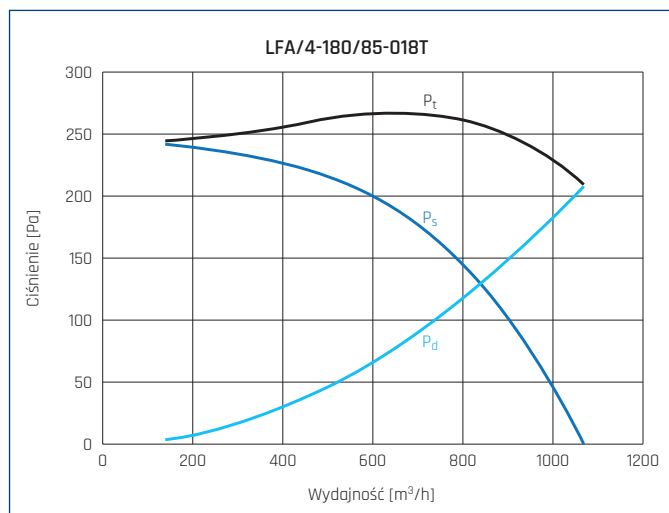

MC	EC	VSD	SR	η [%]	N	[kW]	[m³/h]	[Pa]	[RPM]
B	Całkowita	Nie	1	39,0	49,7	0,1	743	264	1400

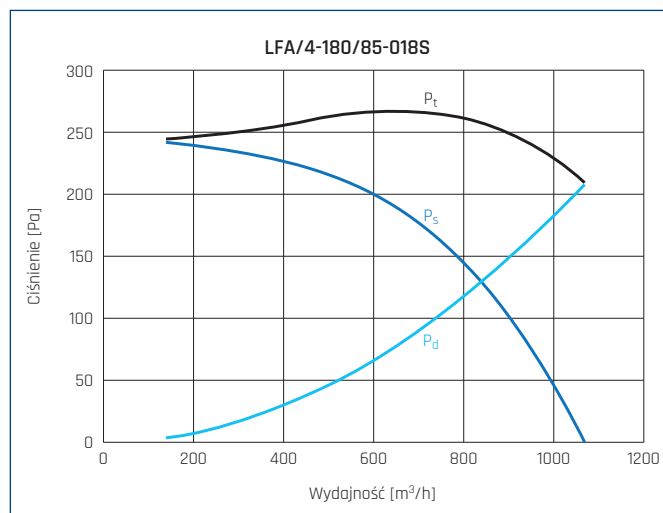

MC	EC	VSD	SR	η [%]	N	[kW]	[m³/h]	[Pa]	[RPM]
B	Całkowita	Nie	1	39,0	49,7	0,1	743	264	1400

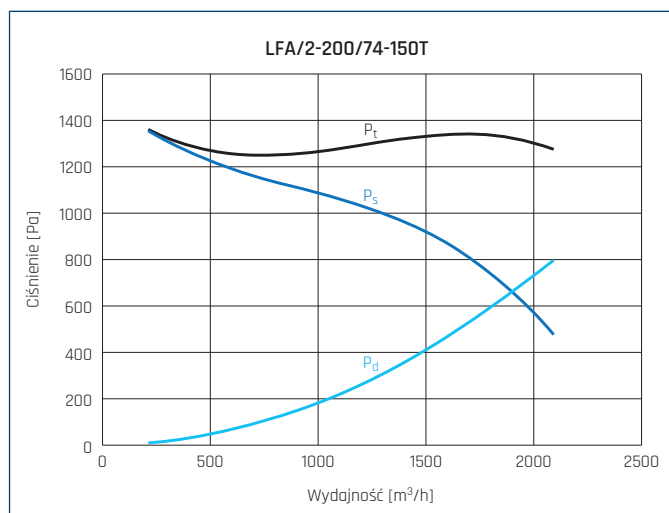

MC	EC	VSD	SR	η [%]	N	[kW]	[m³/h]	[Pa]	[RPM]
B	Całkowita	Nie	1	45,4	51,3	1,2	1452	1327	2880

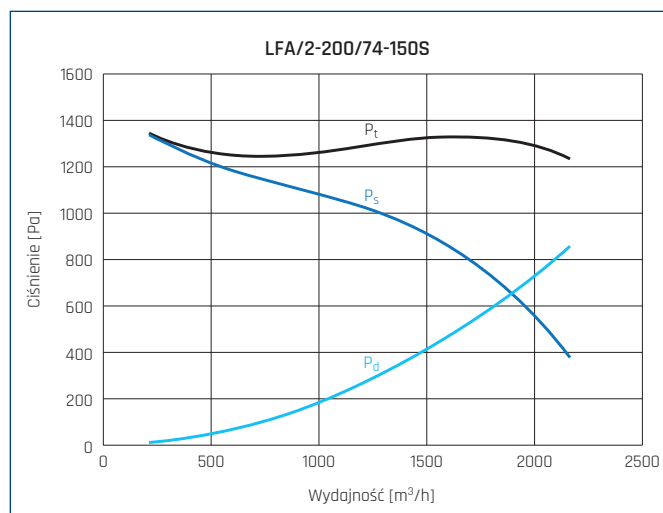

MC	EC	VSD	SR	η [%]	N	[kW]	[m³/h]	[Pa]	[RPM]
B	Całkowita	Nie	1	45,2	52,0	1,3	1602	1324	2943

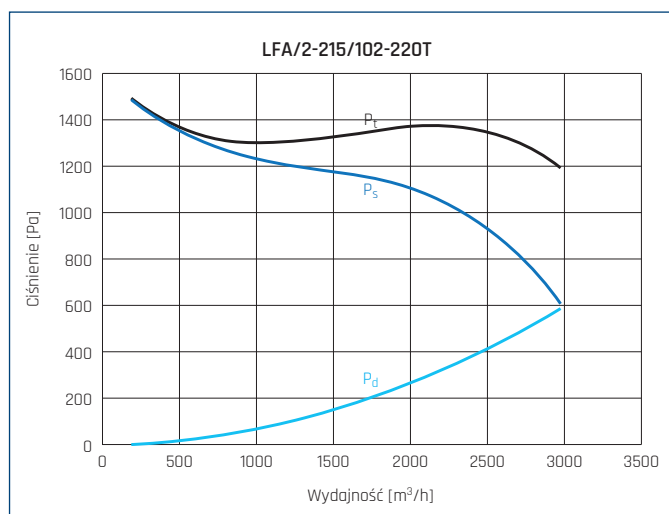

MC	EC	VSD	SR	η [%]	N	[kW]	[m³/h]	[Pa]	[RPM]
B	Całkowita	Nie	1	44,4	49,3	1,7	1900	1402	2944

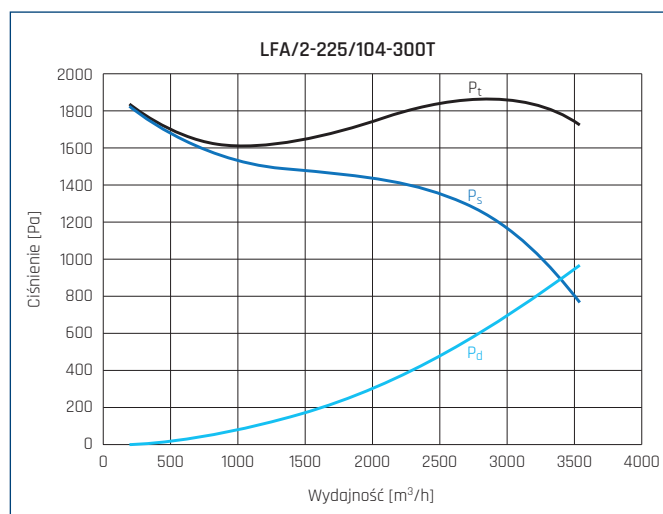

MC	EC	VSD	SR	η [%]	N	[kW]	[m³/h]	[Pa]	[RPM]
B	Całkowita	Nie	1	54,6	58,3	2,6	2854	1838	2921

CHARAKTERYSTYKI PRACY

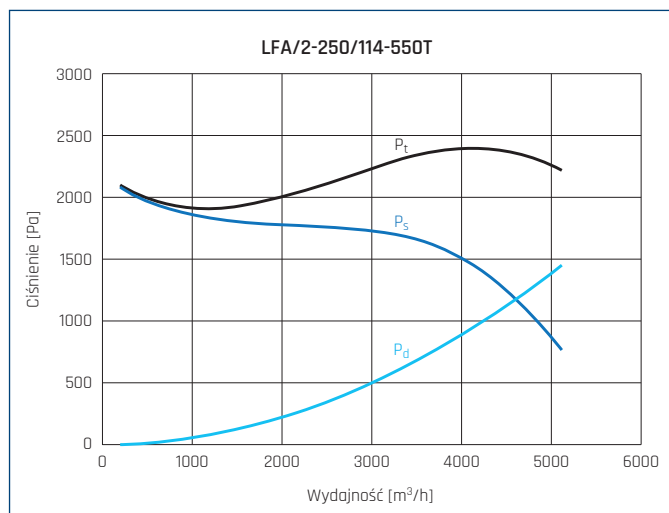

MC	EC	VSD	SR	η[%]	N	[kW]	[m³/h]	[Pa]	[RPM]
B	Całkowita	Nie	1	60,0	62,6	3,8	3579	2332	3184

WYMIARY [mm]

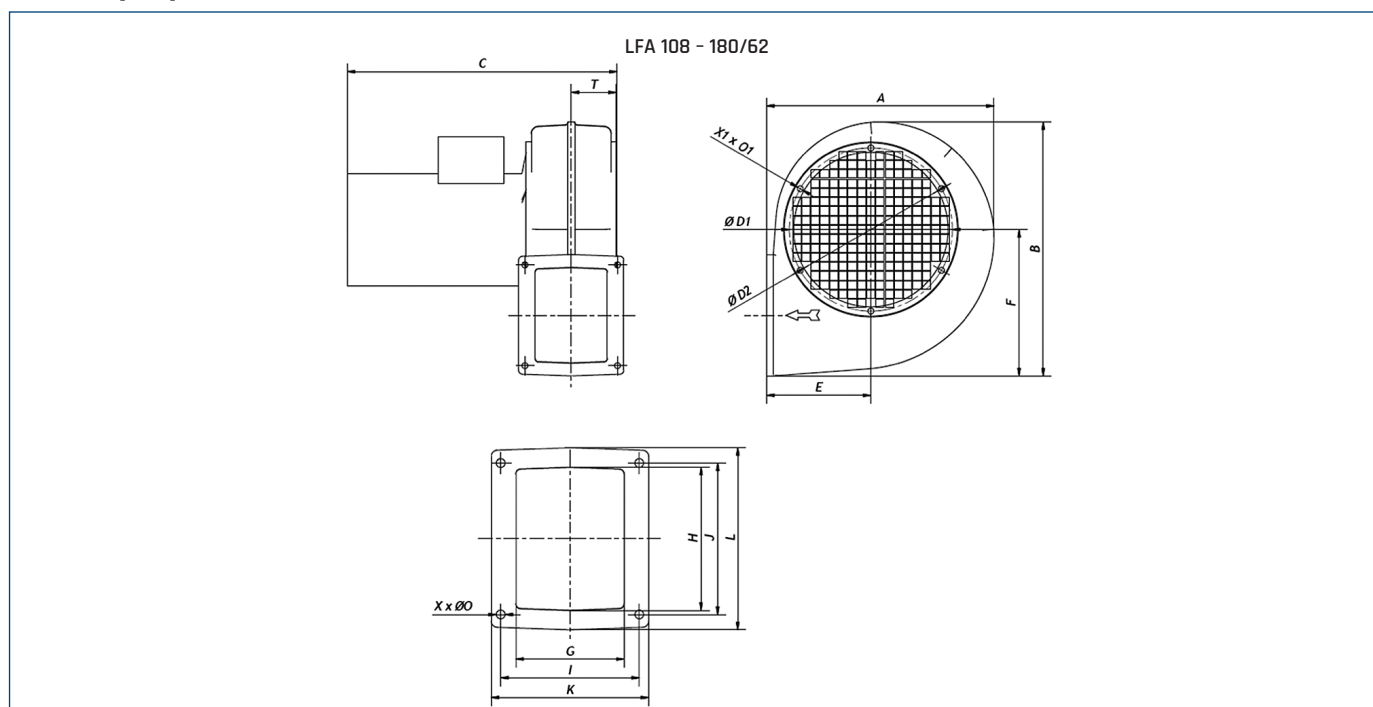

Typ	A	B**	C*	ØD1	ØD2	E	F	G	H	I	J	K	L	T	X	Ø0	X1	Ø01
LFA/2-108/42-005	183	182(**201)	241	120	110	94	103	52	52	56	56	72	72	43	4	7	4	M5
LFA/4-108/42-006	183	182(**201)	254	120	110	94	103	52	52	56	56	72	72	43	4	7	4	M5
LFA/2-120/52-012T	254	254	283	157	135	130	135	86	86	96	96	112	114	55	4	7	4	M5
LFA/4-120/52-006	254	254	283	157	135	130	135	86	86	96	96	112	114	55	4	7	4	M5
LFA/2-133/62-018	254	251(**253)	297	157	135	130	142	86	86	96	96	112	114	55	4	7	4	M5
LFA/4-133/62-006	254	251	283	157	135	130	142	86	86	96	96	112	114	55	4	7	4	M5
LFA/2-146/62-025	254	254	296	157	141	130	142	86	86	96	96	112	114	55	4	7	4	M5
LFA/4-146/62-006	254	254	283	157	141	130	142	86	86	96	96	112	114	55	4	7	4	M5
LFA/2-160/75-037	271	302	300	194	184	124	174	86	113	110	120	125	144	54,5	4	7	4	M6
LFA/4-160/75-009	271	302	300	194	184	124	174	86	113	110	120	125	144	54,5	4	7	4	M6
LFA/2-180/62-055T	271	302	321	194	184	124	174	86	113	110	120	125	144	54,5	4	7	6	M6
LFA/2-180/62-055S	271	302	338	194	184	124	174	86	113	110	120	125	144	54,5	4	7	6	M6
LFA/4-180/62-012	271	302	296	194	184	124	174	86	113	110	120	125	144	55	4	7	6	M6

* wymiar C może się różnić w zależności od silnika

** wysokość z puszką silnika

WYMIARY [mm]

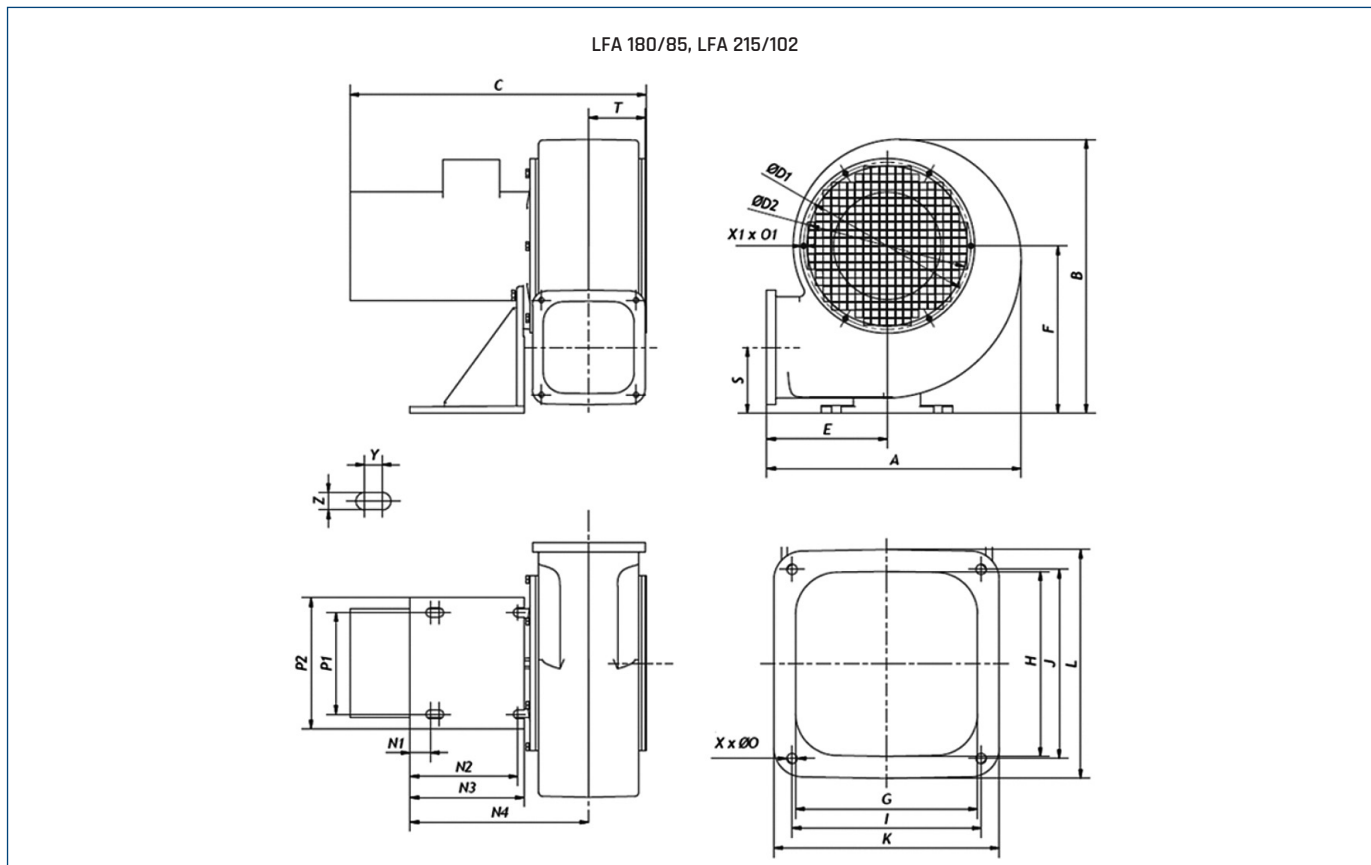

Typ	A	B	C*	ØD1	ØD2	E	F	G	H	I	J	K	L	N1	N2	N3	N4	P1	P2	S	T	X	Ø0	X1	Ø01	Y	Z
LFA/2-180/85-110	349	377	407	230	220	165	230	125	127	130	130	155	157	28	148	157	245	140	180	90	78	4	7	6	M6	12	12
LFA/4-180/85-018	349	377	350	230	210	165	230	125	127	130	130	155	157	28	148	157	237	140	180	90	78	4	7	6	M6	12	12
LFA/2-200/74-150	349	377	471	230	218	165	230	125	127	130	130	155	157	28	148	190	241	140	180	90	78	4	7	6	M6	12	12

* wymiar C może się różnić w zależności od silnika

WYMIARY [mm]

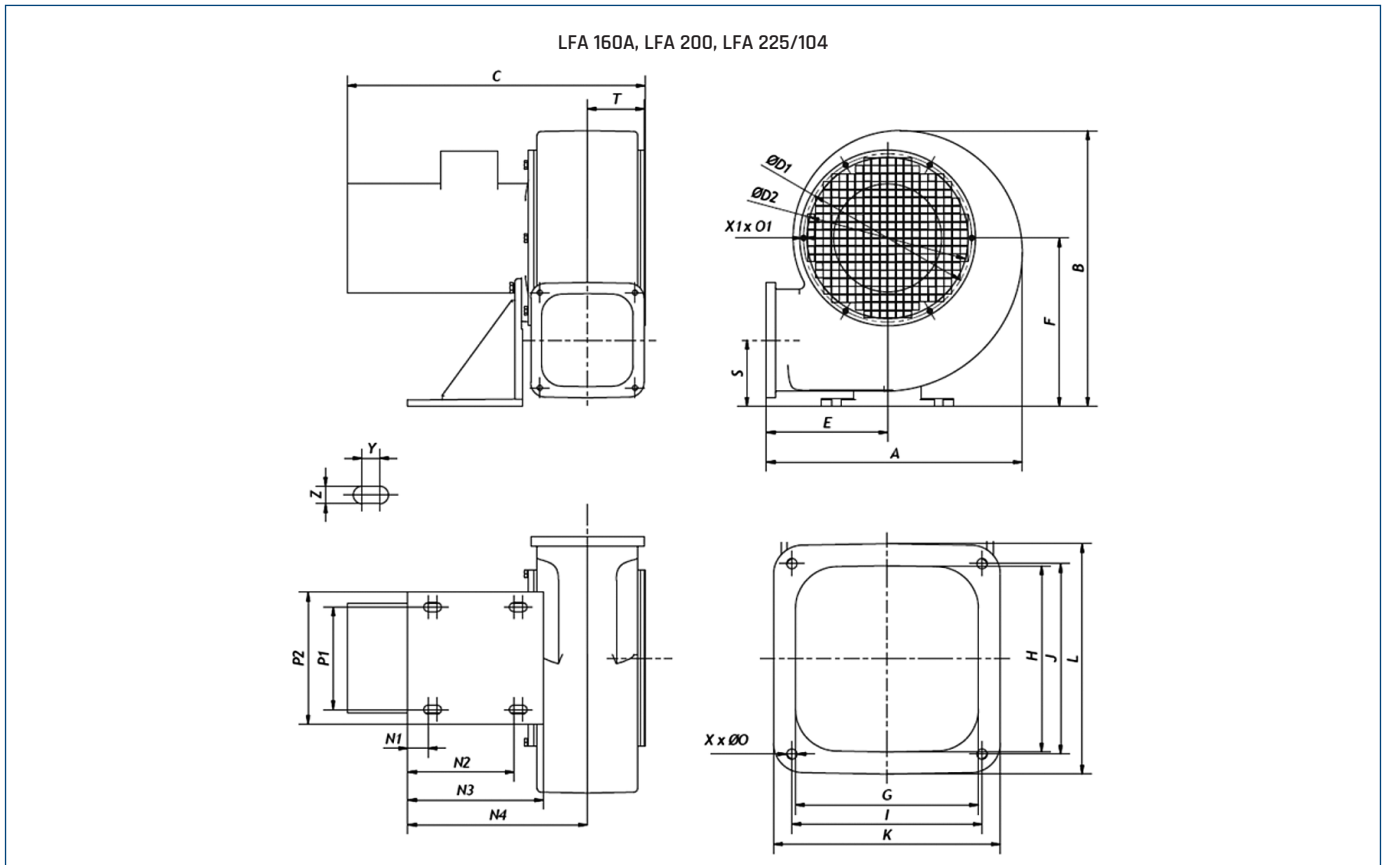

Typ	A	B	C*	ØD1	ØD2	E	F	G	H	I	J	K	L	N1	N2	N3	N4	P1	P2	S	T	X	Ø0	X1	Ø01	Y	Z
LFA/2-160A/62-055T	286	312	304	176	160	140	185	110	110	115	115	140	147	20	120	150	235	95	125	78	69	4	9	4	M5	11	10
LFA/2-160A/62-055S	286	312	304	176	160	140	185	110	110	115	115	140	147	20	120	150	235	95	125	78	69	4	9	4	M5	11	10
LFA/4-160A/62-018T	286	312	286	176	160	140	185	110	110	115	115	140	147	20	120	150	235	95	125	78	69	4	9	4	M5	11	10
LFA/4-160A/62-018S	286	312	286	176	160	140	185	110	110	115	115	140	147	20	120	150	235	95	125	78	69	4	9	4	M5	11	10
LFA/2-225/104-300T	399	450	488	256	235	170	265	155	158	166	166	190	190	29	149	190	297	140	180	100	89	4	12	8	M6	13	12

* wymiar C może się różnić w zależności od silnika

WYMIARY [mm]

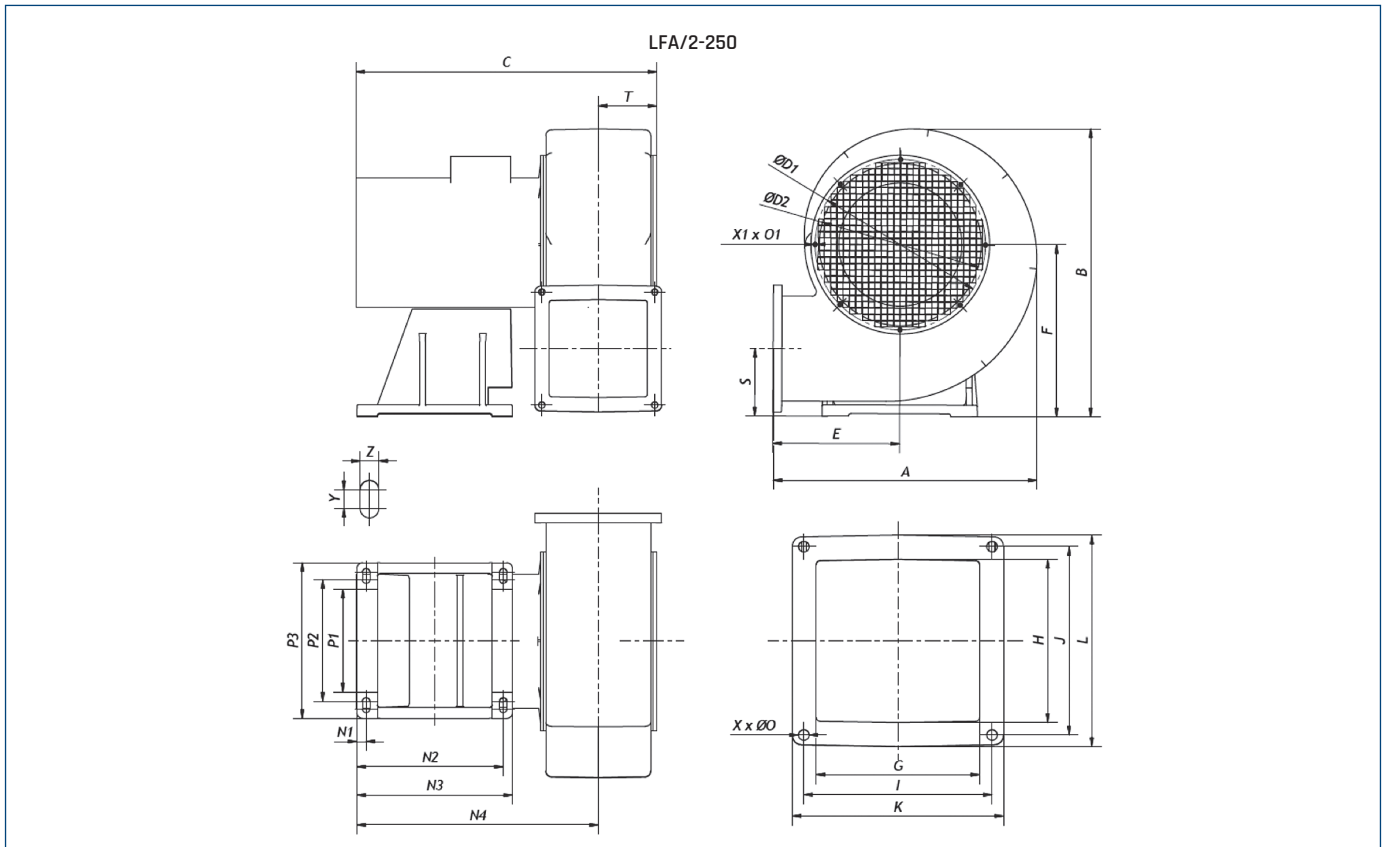

Typ	A	B	C*	ØD1	ØD2	E	F	G	H	I	J	K	L	N1	N2	N3	N4	P1	P2	P3	S	T	X	Ø0	X1	Ø01	Y	Z
LFA/2-250/114-550T	458	499	534	296	281	220	298	170	170	196	196	220	220	16	254	270	419	178	211	270	117	102	4	11	8	M6	13	13

* wymiar C może się różnić w zależności od silnika

AKCESORIA MONTAŻOWE

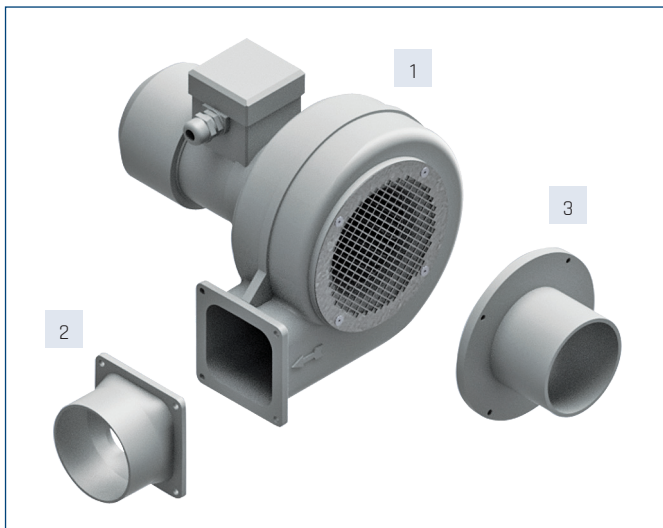

Wentylator	Wylot	Wlot	
	1	2	3
	Króciec wylotowy	Króciec ssawny	
LFA-108/42	-	-	
LFA-120/52	24510047-11 (Ø100)	24510047-12 (Ø100)	
LFA-133/62	24510047-11 (Ø100)	24510047-12 (Ø100)	
LFA-146/62	24510047-11 (Ø100)	24510047-12 (Ø100)	
LFA-160/75	24510053 (Ø100)	24510049 (Ø150)	
LFA-180/62	24510053 (Ø100)	24510094-01 (Ø160)	
LFA-180/85	24510054 (Ø125)	24510085-02 (Ø200)	
LFA-200/74	24510054 (Ø125)	24510085-02 (Ø200)	
LFA-215/102	24510056 (Ø200)	24510085-03 (Ø200)	
LFA-225/104	24510057 (Ø160)	25070061-07 (Ø200)	
LFA-250/114	24510058 (Ø250)	42517310 (Ø250)	



AKCESORIA ELEKTRYCZNE

Wentylator	termostat ścienny	termostat kanałowy
	TS	TK-1
LFA/2-108/42-003S	TS	TK-1
LFA/4-108/42-006S	TS	TK-1
LFA/4-120/52-006S	TS	TK-1
LFA/2-133/62-018S	TS	TK-1
LFA/4-133/62-006S	TS	TK-1
LFA/2-146/62-025S	TS	TK-1
LFA/4-146/62-006S	TS	TK-1
LFA/2-160/75-037S	-	TK-1
LFA/4-160/75-009S	TS	TK-1
LFA/2-180/62-055S	-	-
LFA/4-180/62-018S	TS	TK-1
LFA/2-180/85-110S	-	-
LFA/4-180/85-018S	TS	TK-1
LFA/2-200/74-150S	-	-

Wentylator	Falownik
LFA/2-108/42-005T	L 0.4kW
LFA/4-108/42-006T	L 0.4kW
LFA/2-120/52-012T	L 0.4kW
LFA/4-120/52-006T	L 0.4kW
LFA/2-133/62-018T	L 0.4kW
LFA/4-133/62-006T	L 0.4kW

Wentylator	Falownik
LFA/2-146/62-025T	L 0.4kW
LFA/4-146/62-006T	L 0.4kW
LFA/2-160/75-037T	L 0.4kW
LFA/4-160/75-009T	L 0.4kW
LFA/2-180/62-055T	L 0.75kW
LFA/4-180/62-012T	L 0.4kW

Wentylator	Falownik
LFA/2-180/85-110T	L 1.5kW
LFA/4-180/85-018T	L 0.4kW
LFA/2-200/74-150T	L 1.5kW
LFA/2-215/102-220T	L 2.2kW
LFA/2-225/104-300T	L 4.0kW
LFA/2-250/114-550T	L 5.5kW

Numery artykułów

TS	40025345	L 0.4kW	40016302	L 1.5kW	40016322	L 4.0kW	40016352		
TK-1	40025330	L 0.75kW	40016312	L 2.2kW	40016332	L 5.5kW	40016362		

